



TIME DOMAIN
PULSE POWER SENSOR

7027 SERIES

OPERATION MANUAL

©COPYRIGHT 2020 BY BIRD TECHNOLOGIES INC.
INSTRUCTION BOOK PART NUMBER 920-7027S REV. B

THRULINE® IS A REGISTERED TRADEMARK
OF BIRD ELECTRONIC CORPORATION

Safety Precautions

The following are general safety precautions that are not necessarily related to any specific part or procedure, and do not necessarily appear elsewhere in this publication. These precautions must be thoroughly understood and apply to all phases of operation and maintenance.

WARNING

Keep Away From Live Circuits

Operating Personnel must at all times observe general safety precautions. Do not replace components or make adjustments to the inside of the test equipment with the high voltage supply turned on. To avoid casualties, always remove power.

WARNING

Shock Hazard

Do not attempt to remove the RF transmission line while RF power is present.

WARNING

Do Not Service Or Adjust Alone

Under no circumstances should any person reach into an enclosure for the purpose of service or adjustment of equipment except in the presence of someone who is capable of rendering aid.

WARNING

Safety Earth Ground

An uninterruptible earth safety ground must be supplied from the main power source to test instruments. Grounding one conductor of a two conductor power cable is not sufficient protection. Serious injury or death can occur if this grounding is not properly supplied.

WARNING

Resuscitation

Personnel working with or near high voltages should be familiar with modern methods of resuscitation.

WARNING

Remove Power

Observe general safety precautions. Do not open the instrument with the power on.

Safety Symbols

WARNING

Warning notes call attention to a procedure, which if not correctly performed, could result in personal injury.

CAUTION

Caution notes call attention to a procedure, which if not correctly performed, could result in damage to the instrument.



The caution symbol appears on the equipment indicating there is important information in the instruction manual regarding that particular area

Note: *Calls attention to supplemental information.*

Warning Statements

The following safety warnings appear in the text where there is danger to operating and maintenance personnel, and are repeated here for emphasis.

WARNING

Never attempt to connect or disconnect RF equipment from the transmission line while RF power is being applied.
Leaking RF energy is a potential health hazard.

On page 6.

Safety Statements

USAGE

ANY USE OF THIS INSTRUMENT IN A MANNER NOT SPECIFIED BY THE MANUFACTURER MAY IMPAIR THE INSTRUMENT'S SAFETY PROTECTION.

USO

EL USO DE ESTE INSTRUMENTO DE MANERA NO ESPECIFICADA POR EL FABRICANTE, PUEDE ANULAR LA PROTECCIÓN DE SEGURIDAD DEL INSTRUMENTO.

BENUTZUNG

WIRD DAS GERÄT AUF ANDERE WEISE VERWENDET ALS VOM HERSTELLER BESCHRIEBEN, KANN DIE GERÄTESICHERHEIT BEEINTRÄCHTIGT WERDEN.

UTILISATION

TOUTE UTILISATION DE CET INSTRUMENT QUI N'EST PAS EXPLICITEMENT PRÉVUE PAR LE FABRICANT PEUT ENDOMMAGER LE DISPOSITIF DE PROTECTION DE L'INSTRUMENT.

IMPIEGO

QUALORA QUESTO STRUMENTO VENISSE UTILIZZATO IN MODO DIVERSO DA COME SPECIFICATO DAL PRODUTTORE LA PROZIONE DI SICUREZZA POTREBBE VENIRNE COMPROMESSA.

SERVICE

SERVICING INSTRUCTIONS ARE FOR USE BY SERVICE - TRAINED PERSONNEL ONLY. TO AVOID DANGEROUS ELECTRIC SHOCK, DO NOT PERFORM ANY SERVICING UNLESS QUALIFIED TO DO SO.

SERVICIO

LAS INSTRUCCIONES DE SERVICIO SON PARA USO EXCLUSIVO DEL PERSONAL DE SERVICIO CAPACITADO. PARA EVITAR EL PELIGRO DE DESCARGAS ELÉCTRICAS, NO REALICE NINGÚN SERVICIO A MENOS QUE ESTÉ CAPACITADO PARA HACERLO.

WARTUNG

ANWEISUNGEN FÜR DIE WARTUNG DES GERÄTES GELTEN NUR FÜR GESCHULTES FACHPERSONAL.

ZUR VERMEIDUNG GEFÄHRLICHE, ELEKTRISCHE SCHOCKS, SIND WARTUNGSARBEITEN AUSSCHLIEßLICH VON QUALIFIZIERTEM SERVICEPERSONAL DURCHZUFÜHREN.

ENTRETIEN

L'EMPLOI DES INSTRUCTIONS D'ENTRETIEN DOIT ÊTRE RÉSERVÉ AU PERSONNEL FORMÉ AUX OPÉRATIONS D'ENTRETIEN. POUR PRÉVENIR UN CHOC ÉLECTRIQUE DANGEREUX, NE PAS EFFECTUER D'ENTRETIEN SI L'ON N'A PAS ÉTÉ QUALIFIÉ POUR CE FAIRE.

ASSISTENZA TECNICA

LE ISTRUZIONI RELATIVE ALL'ASSISTENZA SONO PREVISTE ESCLUSIVAMENTE PER IL PERSONALE OPPORTUNAMENTE ADDESTRATO. PER EVITARE PERICOLOSE SCOSSE ELETTRICHE NON EFFETTUARE ALCUNA RIPARAZIONE A MENO CHE QUALIFICATI A FARLA.

About This Manual

This manual covers the operating and maintenance instructions for the following models:

7027 Series

Changes to this Manual

We have made every effort to ensure this manual is accurate. If you discover any errors, or if you have suggestions for improving this manual, please send your comments to our Solon, Ohio factory. This manual may be periodically updated. When inquiring about updates to this manual refer to the part number and revision on the title page.

Literature Contents

Chapter Layout

Introduction — Describes the features of the Bird 7027 Series Power Sensor.

Installation — Describes how to connect Bird 7027 Series Power Sensor to the user's system, and software requirements.

Operation — Describes the power measurement process.

Maintenance — Lists routine maintenance tasks as well as a specifications and model features identification.

TABLE OF CONTENTS

Safety Precautions	i
Safety Symbols	ii
Warning Statements	ii
Safety Statements	iii
About This Manual	v
Changes to this Manual	v
Literature Contents	v
Chapter Layout	v
Chapter 1 Introduction	1
General Description	1
Measurement	1
Sync Pulse	2
Data Communication Options	2
Status Indicator	2
Chapter 2 USB Model Pulse Sensor	3
Monitor/Control	3
Measurement	3
Power Requirements	4
Software	4
Interlock Switch	4
Interlock wiring	5
Installing the 7027 USB Model Pulse Power Sensor	6
Install optional interlock bracket	6
Chapter 3 Ethernet Model Pulse Sensor	7
Monitor/Control	7
Measurement	7
Power Requirements	8
IP Address	8

IP Address Configuration	9
Installing the 7027 Ethernet Model Pulse Power Sensor	10
Firmware Update	10
Firmware Update Procedure	10
Chapter 4 Theory of Operation.....	13
Measurement Process	13
Chapter 5 Maintenance.....	14
Customer Service	14
Shipment	14
Specifications	15
Model Identification	17
Limited Warranty	18

The Bird Precision Pulse Power Sensor for precision semiconductor applications.

General Description

The 7027 Series Power Sensors were designed to bring superb accuracy and ease of use together for the engineer in the laboratory and semiconductor fabrication environments. At the calibrated frequencies, these sensors are capable of 1% accuracy measurements of the gated power within a pulsed waveform.

Measurement

The 7027 is capable of measuring multi-level pulsed waveforms. It measures the average power, gated power, rise and fall times of up to four levels (states) within a pulse period. See [Figure 1](#).

Figure 1 Multi-level Pulsed Waveform Measurement

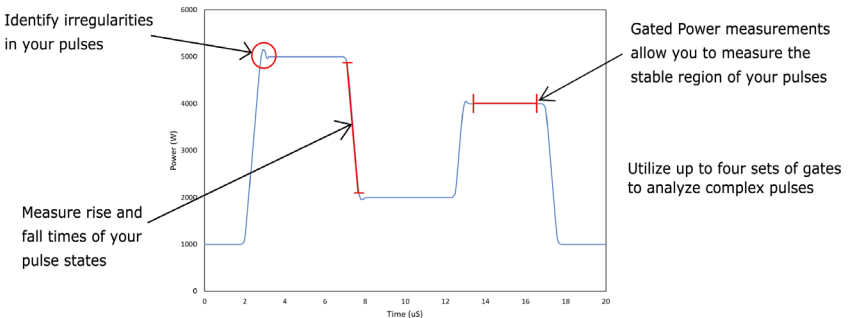

See [Chapter 4 Theory of Operation on page 13](#) for a complete explanation of the measurement process.

The input and output connectors of the Bird 7027 Series Power Sensor are Bird Quick-Change type RF connectors, which allow the sensor to be reconfigured with other Bird “QC” connectors. See [Figure 2 on page 4](#).

Note: *Recalibration is required following any connector changes to guarantee rated accuracy.*

Sync Pulse

The pulsed waveform measurement uses an internal reference signal to synchronize the measurement with start of the pulse period.

If desired, the measurement may be referenced to an external sync pulse. A Sync Pulse input is provided for external sync pulse control of the measurement period. The requirements for the sync pulse input are defined in ["Specifications" on page 15](#).

Data Communication Options

The Pulse Sensor is available with two data communication options:

- USB - The USB communication model is designed for use with Bird's VPM3 software or may also be controlled using Standard Commands for Programmable Instrumentation (SCPI) over USB. See ["USB Model Pulse Sensor" on page 3](#).
- Ethernet - The Ethernet communications model is controlled using Standard Commands for Programmable Instrumentation (SCPI) over Ethernet. See ["Ethernet Model Pulse Sensor" on page 7](#).

Refer to the 7027 Pulse Sensor Programming manual for details regarding SCPI commands.

Status Indicator

A status indicator is provided to inform the user of the power sensors operating condition.

Indicator Color	Definition
Green (solid)	Sensor is operating normally.
Blue (solid)	Sensor is booting up.
Magenta (solid)	Sensor is in programming mode.
Yellow (solid/blinking)	Sensor communication error.
Any indications other than those provided here represent non-recoverable errors, contact Bird Customer Service.	

A reset pushbutton is provided to enable programming mode.

The USB model Pulse Sensors receive power and communicate over the USB port.

Monitor/Control

Bird's Virtual Power Meter (VPM3) software may be used to provide control and monitoring of the sensor. A USB cable is used to connect the Power Sensor to a PC running the VPM3 software.

The USB sensor may also be controlled using Standard Commands for Programmable Instrumentation (SCPI) over USB. Refer to the 7027 Pulse Sensor Programming manual for details regarding SCPI commands.

Measurement

The 7027 is a multi-level pulse power sensor. It measures the average power of up to four levels within a pulse period. Each state is defined with begin and end times within the VPM3 user interface (State Average Measurement). The begin and end times are referenced to the internal reference signal or may be referenced to an external sync pulse. See [Chapter 4 Theory of Operation on page 13](#) for a complete explanation.

Figure 2 USB Model Pulse Power Sensor

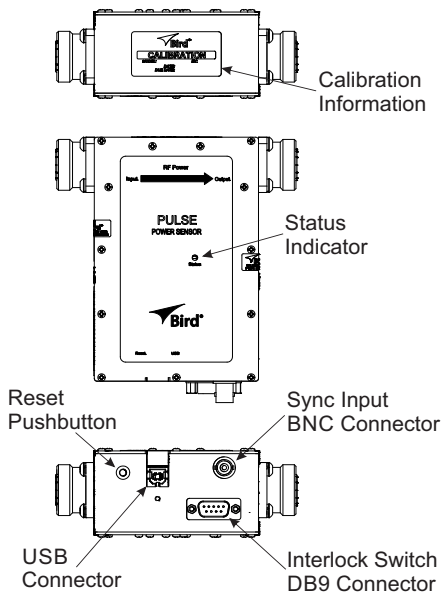

Power Requirements

The Bird 7027 Series Power Sensor operates on power provided by the USB cable connection, no other power source is required.

Software

Bird's VPM3 software is required to operate the Bird 7027 Series Power Sensor. The software must be installed before operation.

Interlock Switch

The 7027 sensor contains a normally open interlock switch for interlock control of the connected RF source. An optional bracket is available that, when installed, closes the interlock circuit. When installed, the interlock bracket ensures the RF cables cannot be disconnected from the sensor's RF input and output connectors, see [Figure 3](#). When the RF source is connected to the interlock circuit via the sensor's DB9 connector, if the interlock bracket is removed, the interlock circuit opens and the RF source is disabled.

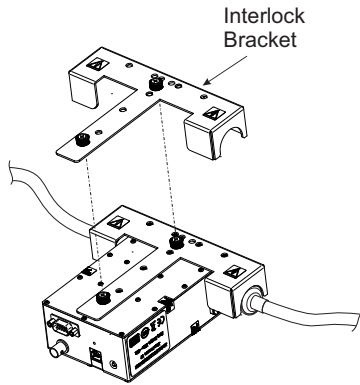
Figure 3 Interlock Bracket

Interlock wiring

The DB9 connector is used to connect the sensor's interlock circuitry to the RF Source. The internal interlock switch is connected to **Pin 1** and **Pin 6** of the DB9 connector. The interlock is normally open, attaching an interlock bracket to the sensor will close the interlock circuit.

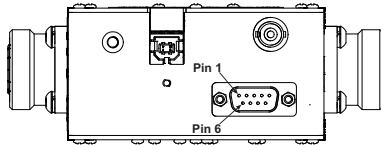
Figure 4 Interlock Pinout

Installing the 7027 USB Model Pulse Power Sensor

WARNING

Never attempt to connect or disconnect RF equipment from the transmission line while RF power is being applied.
Leaking RF energy is a potential health hazard.

1. Insert the 7027 Power Sensor into a coaxial transmission line of 50 ohms nominal impedance.

Note: *Connect the 7027 Power Sensor to the RF line so that the arrow on the sensor points towards the load.*

2. Connect the USB Type A (flat) connector to the PC.
3. Connect the USB Type B (square) connector to the power sensor.
4. Open Devices and Printers dialog box. (\\Control Panel\Hardware and Sound\Devices and Printers).
5. Verify the Power Sensor's device drivers are installed correctly.

Note: *Refer to the VPM3 operation manual for detailed descriptions of menus and displays. The VPM3 software and manual are available on the Bird Technologies website (<http://www.birdrf.com>).*

6. If an external sync pulse signal will be used, connect the BNC plug on the sync pulse input cable to the BNC connector in the bottom of the sensor.
7. Refer to the VPM3 Operation Manual or the 7027 SCPI programming manual for control and monitoring of the Pulse Power Sensor.

Install optional interlock bracket

Note: *Connect RF Cables to the input and output connectors of the sensor prior to performing this procedure.*

1. Connect the RF source interlock cable to the DB9 connector on the 7027 sensor. See "[Interlock wiring](#)" on page 5 for connector pinout.
2. Position the interlock bracket on the back of the sensor so the input and out put connectors are covered. See [Figure 3 on page 5](#).
3. Tighten the two thumb screws to secure the bracket to the sensor.

CHAPTER 3 ETHERNET MODEL PULSE SENSOR

The Ethernet model Pulse Sensors communicate over Ethernet and receive power from an AC/DC power supply.

Monitor/Control

The Ethernet sensor is controlled using Standard Commands for Programmable Instrumentation (SCPI) over Ethernet. Refer to the 7027 Pulse Sensor Programming manual for details regarding SCPI commands.

Measurement

The 7027 is a multi-level pulse power sensor. It measures the average power of up to four levels within a pulse period. Each state is defined with begin and end times. The begin and end times are referenced to the internal reference signal or may be referenced to an external sync pulse. See [Chapter 4 Theory of Operation on page 13](#) for a complete explanation.

Figure 5 Ethernet Model Pulse Power Sensor

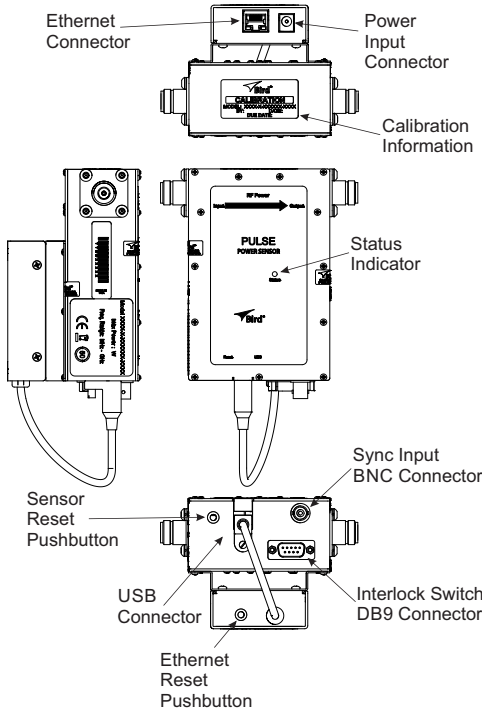

Power Requirements

The Ethernet model Pulse Power Sensor operates on 5 VDC power input provided by the AC adapter supplied with the sensor.

IP Address

The Ethernet address for the Pulse Sensor may be set to any address required for the monitoring/controlling system. See "[Model Identification](#)" on page 17 for model number center frequency to determine default IP Address below.

Default IP Address:

- IP Address: 192.168.1.151
- Netmask: 255.255.255.0
- Gateway: 192.168.1.1

Note: To reset the sensor's Ethernet address to default, press and hold the Ethernet reset pushbutton for five seconds.

IP Address Configuration

Note: To change the sensor's IP address, the PC connected to the Power Sensor must be on the same subnet.

1. Connect an Ethernet cable to the PC.
2. Connect the remaining end of the Ethernet cable to the power sensor.
3. Open a web browser on the PC.
4. Type the Sensor's default IP Address into the browser's address box, then press Enter.

Figure 6 Pulse Sensor Configuration Menu



- [Update](#)
- [Network Configuration](#)
- [Firmware Version](#)



5. Click Network Configuration once the Pulse Sensor's configuration menu is displayed.
6. Type in the new IP Address, netmask, and Gateway, then click Submit.

Figure 7 Network Configuration Utility



Network Configuration:

Set network configuration by filling form with desired settings. After submitting updated settings, the device must be power cycled before changes will take effect.

- IP Address:
 - netmask:
 - Gateway:
-



Installing the 7027 Ethernet Model Pulse Power Sensor

WARNING

Never attempt to connect or disconnect RF equipment from the transmission line while RF power is being applied.
Leaking RF energy is a potential health hazard.

1. Insert the 7027 Power Sensor into a coaxial transmission line of 50 ohms nominal impedance.

Note: *Connect the 7027 Power Sensor to the RF line so that the arrow on the sensor points towards the load.*
2. Connect an Ethernet cable to the PC.
3. Connect the remaining end of the Ethernet cable to the power sensor.
4. Connect the 5 VDC Power supply output to the power input connector on the Power Sensor.
5. If an external sync pulse signal will be used, connect the BNC plug on the sync pulse input cable to the BNC connector in the bottom of the sensor.
6. Refer to the 7027 SCPI programming manual for control and monitoring of the Pulse Power Sensor.

Firmware Update

Firmware updates may be released periodically for the Ethernet Bridge on the 7027 Power Sensor. Firmware updates will be posted on the 7027 Power Sensor product page on Bird's website www.birdrf.com.

Firmware Update Procedure

1. Go to <http://www.birdrf.com/>, search for 7027, or go to product page.
2. Check the "Downloads" section of the product page for firmware packages.
3. Click on the firmware update on the product page.

A dialog will open to save the firmware update "zip" file, select a location and save the file.
4. Extract the firmware from the "zip" file.

Note: *A new folder containing more folders inside it should be created.*
5. Connect the PC to the 7027 Power Sensor via an Ethernet cable.
 - a. Connect an Ethernet cable to the PC.
 - b. Connect the remaining end of the Ethernet cable to the power sensor.

- c. Open a web browser on the PC.
 - d. Type the Sensor's IP Address into the browser's address box, then press Enter.
6. Click on the **Update** link, once the 7027 Ethernet Bridge Web UI opens. See [Figure 8](#).

Figure 8 Pulse Sensor Main Menu

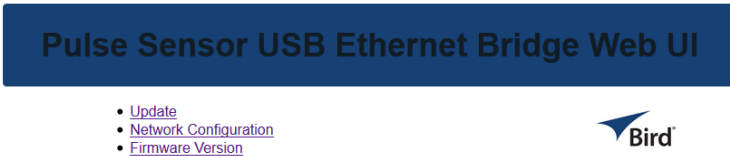

7. The Firmware Update Utility will open, see [Figure 9](#)

Figure 9 Firmware Update file selection

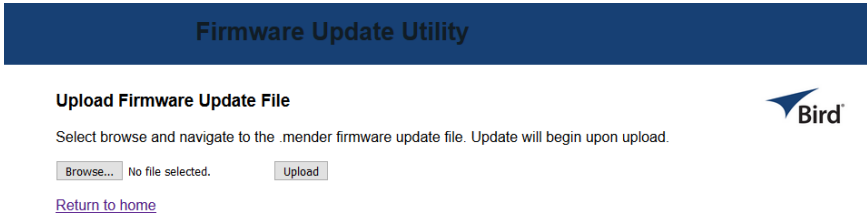

8. Click **Browse** to select the firmware files extracted in [step 4](#).
9. After firmware file is selected click the **Upload** button, see [Figure 9](#).
10. Wait for the update to install and the Ethernet Bridge to reboot, see [Figure 10](#).

Figure 10 Firmware Update Progress Display

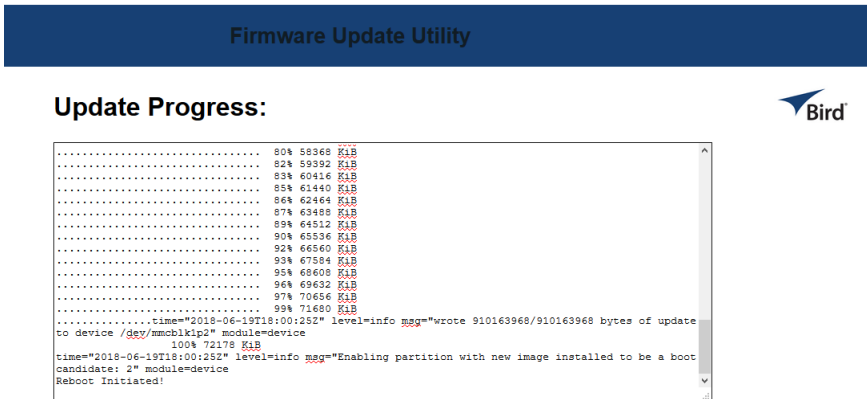

11. Wait at least two minutes following the reboot initiated message to allow Ethernet Bridge to reboot.
12. Type the Sensor's IP Address into the browser's address box, then press Enter.
13. Click Firmware Version link on the Device's main menu, see [Figure 8 on page 11](#).
14. Verify the new Firmware version number is displayed.

Measurement Process

The 7027 measures the average power of up to four states within a pulse period, see [Figure 11](#). Each state is defined with begin and end times. The begin and end times are referenced to the internal reference signal or may be referenced to an external sync pulse.

Figure 11 State Average Measurements

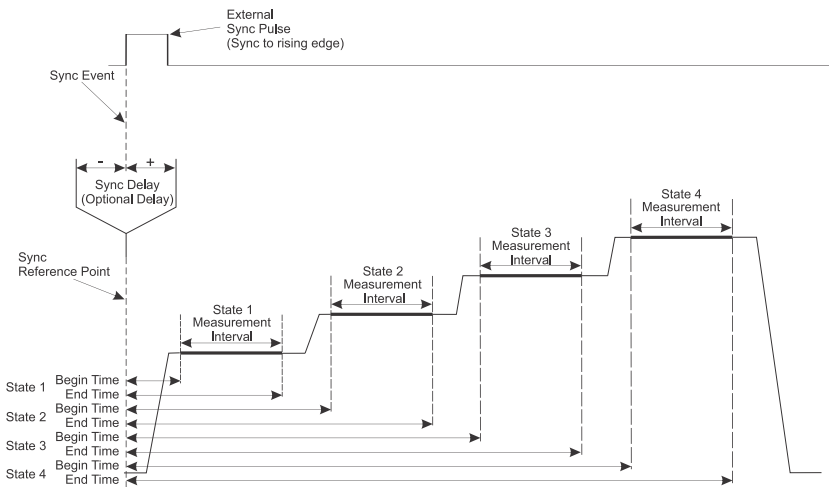

The average pulse power measurement interval for each state begins at the user specified begin time and ends at the user specified end time. There may be four different states specified, each with a begin and end time.

The 7027 Series Power Sensor is of very rugged construction and requires little care and maintenance.

Maintenance of the power sensor is normally limited to cleaning. Protect the RF connectors against the entry of dust and dirt by keeping them covered when the unit is disconnected from the transmission line.

Customer Service

Any maintenance or service procedure beyond the scope of those in this chapter should be referred to a qualified service center.

If the unit needs to be returned for any reason, request an Return Material Authorization (RMA) through the Bird Technologies website. All instruments returned must be shipped prepaid and to the attention of the RMA number.

Bird Service Center

30303 Aurora Road
Cleveland (Solon), Ohio 44139-2794
Fax: (440) 248-5426
E-mail: bsc@birdrf.com

For the location of the Sales Office nearest you, visit our Web site at:

<http://www.birdrf.com>

Shipment

Should you need to return the power sensor, use the original shipping package if possible. If the original package is not available, use a heavy duty corrugated box with shock-absorbing material around all sides of the unit to provide firm cushion and to prevent movement in the container. The container should be properly sealed.

Specifications

Frequency	Varies by model, See “Model Identification” on page 17.
Power Range (Continuous Average Power)	Varies by model, See “Model Identification” on page 17.
Peak Power @ 60% Duty Cycle	Varies by model, the peak power is the upper end of the power range. See “Model Identification” on page 17.
Measurement Type	Thru-Line Power
Impedance, nominal	50 Ohms
Average Power Range	Varies by model, See “Model Identification” on page 17.
Accuracy	1% at calibration frequencies 2% at all other frequency within the sensor bandwidth
VSWR Range	1.0:1 to 2.0:1
Gated Average Power Accuracy	1% at calibration frequencies 2% at all other frequency within the sensor bandwidth
Insertion loss, Max	<0.05 dB
Insertion VSWR, Max	1.05
RF Connectors	QC (Overall power will be limited by connector selection.) See “Model Identification” on page 17 for QC connectors supplied by model number.
Directivity, Min	28 dB
Sync Input	
Input port impedance	>10 kOhms
Input level Pulse ON	TTL High (2.0 V - 5.0 V)
Input level Pulse OFF	TTL Low (0 V - 0.85 V)
Factory Calibration	NIST Traceable
Recommended Calibration Cycle	6 Months
Field Calibration	None
Interface Options	USB 2.0 Ethernet
Power Supply	Via USB, for USB only models (less than 0.5A at 5V) Via 5V AC/DC Power Supply (supplied) for Ethernet models

Physical and Environmental	
Operating Temperature	+15 to +35 C (+59 TO +95 F)
Storage Temperature	-20 to +70 C (-4 to +158 F)
Humidity	95% maximum (non-condensing)
Altitude, Max	15, 000 ft. (4,500 m)
Dimensions, Nominal	6" x 2.0" x 3.7" (140 x 51 x 94 mm) not including RF connectors
Weight, Max	Less than 3 lbs
Mechanical Shock and Vibration	Designed to meet MIL-PRF-28800F class 3
Compliance	Designed to Comply with: EMC Directive (2014/30/EU) European Standard: EN 61326—Electrical Equipment for measurement, control and laboratory use; EMC Requirements Test Spec (for radiated immunity): EN 61000-4-3—Testing and measurement techniques - 10V/meter
RoHS	Compliant
CE Mark	Compliant
Compatible Devices	VPM3
Standard Accessories	USB Cable, VPM3 software

Model Identification

Note: The Model Identification guide is provided to allow existing model numbers to be understood. However, not all combinations are available. Please contact Bird for more information on new model number requests.

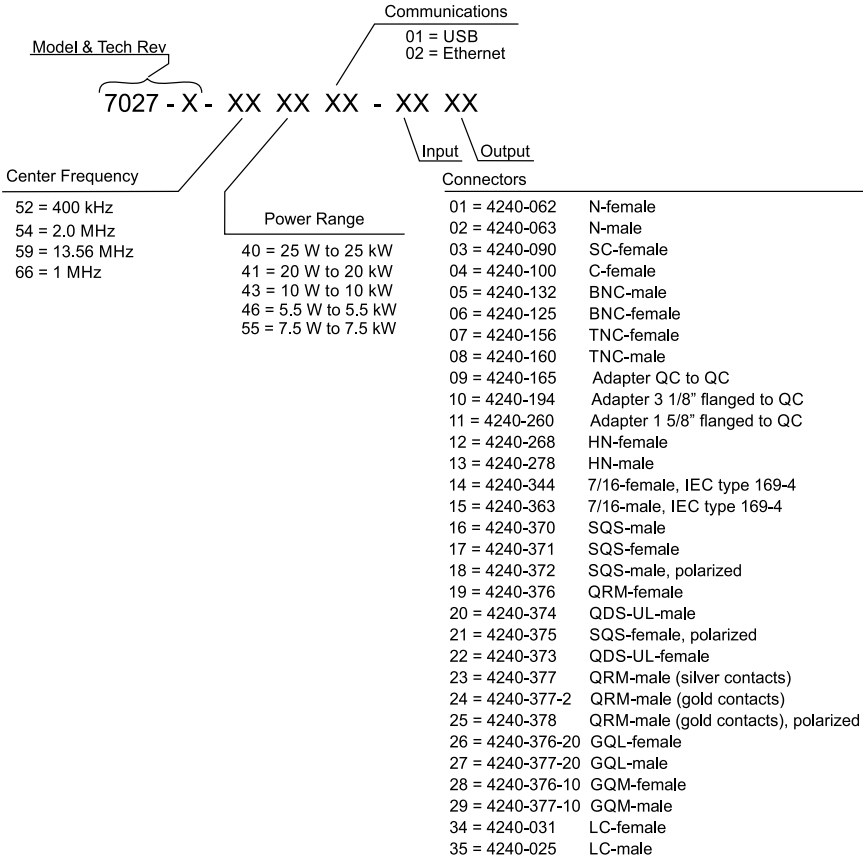

Limited Warranty

All products manufactured by Seller are warranted to be free from defects in material and workmanship for a period of one (1) year, unless otherwise specified, from date of shipment and to conform to applicable specifications, drawings, blueprints and/or samples. Seller's sole obligation under these warranties shall be to issue credit, repair or replace any item or part thereof which is proved to be other than as warranted; no allowance shall be made for any labor charges of Buyer for replacement of parts, adjustment or repairs, or any other work, unless such charges are authorized in advance by Seller.

If Seller's products are claimed to be defective in material or workmanship or not to conform to specifications, drawings, blueprints and/or samples, Seller shall, upon prompt notice thereof, either examine the products where they are located or issue shipping instructions for return to Seller (transportation-charges prepaid by Buyer). In the event any of our products are proved to be other than as warranted, transportation costs (cheapest way) to and from Seller's plant, will be borne by Seller and reimbursement or credit will be made for amounts so expended by Buyer. Every such claim for breach of these warranties shall be deemed to be waived by Buyer unless made in writing within ten (10) days from the date of discovery of the defect.

The above warranties shall not extend to any products or parts thereof which have been subjected to any misuse or neglect, damaged by accident, rendered defective by reason of improper installation or by the performance of repairs or alterations outside of our plant, and shall not apply to any goods or parts thereof furnished by Buyer or acquired from others at Buyer's request and/or to Buyer's specifications. Routine (regularly required) calibration is not covered under this limited warranty. In addition, Seller's warranties do not extend to the failure of tubes, transistors, fuses and batteries, or to other equipment and parts manufactured by others except to the extent of the original manufacturer's warranty to Seller.

The obligations under the foregoing warranties are limited to the precise terms thereof. These warranties provide exclusive remedies, expressly in lieu of all other remedies including claims for special or consequential damages. SELLER NEITHER MAKES NOR ASSUMES ANY OTHER WARRANTY WHATSOEVER, WHETHER EXPRESS, STATUTORY, OR IMPLIED, INCLUDING WARRANTIES OF MERCHANTABILITY AND FITNESS, AND NO PERSON IS AUTHORIZED TO ASSUME FOR SELLER ANY OBLIGATION OR LIABILITY NOT STRICTLY IN ACCORDANCE WITH THE FOREGOING.

