



CHANNEL POWER SENSOR  
MODEL 4042E

OPERATION MANUAL



## Safety Precautions

The following are general safety precautions that are not necessarily related to any specific part or procedure, and do not necessarily appear elsewhere in this publication. These precautions must be thoroughly understood and apply to all phases of operation and maintenance.

### WARNING

#### Keep Away From Live Circuits

Operating Personnel must at all times observe general safety precautions. Do not replace components or make adjustments to the inside of the test equipment with the high voltage supply turned on. To avoid casualties, always remove power.

### WARNING

#### Shock Hazard

Do not attempt to remove the RF transmission line while RF power is present.

### WARNING

#### Do Not Service Or Adjust Alone

Under no circumstances should any person reach into an enclosure for the purpose of service or adjustment of equipment except in the presence of someone who is capable of rendering aid.

### WARNING

#### Safety Earth Ground

An uninterruptible earth safety ground must be supplied from the main power source to test instruments. Grounding one conductor of a two conductor power cable is not sufficient protection. Serious injury or death can occur if this grounding is not properly supplied.

### WARNING

#### Resuscitation

Personnel working with or near high voltages should be familiar with modern methods of resuscitation.

### WARNING

#### Remove Power

Observe general safety precautions. Do not open the instrument with the power applied.

## Safety Symbols

---

**WARNING**

Warnings call attention to a procedure, which if not correctly performed, could result in personal injury.

**CAUTION**

Cautions call attention to a procedure, which if not correctly performed, could result in damage to the instrument.

**NOTE**

*Notes call attention to supplemental information.*

## Warning Statements

---

The following safety warnings appear in the text where there is danger to operating and maintenance personnel, and are repeated here for emphasis.

**WARNING**

**Leaking RF energy is a potential health hazard. Never attempt to connect or disconnect equipment from the transmission line while RF power is being applied. Severe burns, electrical shock, or death can occur.**

Refer to page 9.

## **Safety Statements**

---

### **USAGE**

ANY USE OF THIS INSTRUMENT IN A MANNER NOT SPECIFIED BY THE MANUFACTURER MAY IMPAIR THE INSTRUMENT'S SAFETY PROTECTION.

### **USO**

EL USO DE ESTE INSTRUMENTO DE MANERA NO ESPECIFICADA POR EL FABRICANTE, PUEDE ANULAR LA PROTECCIÓN DE SEGURIDAD DEL INSTRUMENTO.

### **BENUTZUNG**

WIRD DAS GERÄT AUF ANDERE WEISE VERWENDET ALS VOM HERSTELLER BESCHRIEBEN, KANN DIE GERÄTESICHERHEIT BEEINTRÄCHTIGT WERDEN.

### **UTILISATION**

TOUTE UTILISATION DE CET INSTRUMENT QUI N'EST PAS EXPLICITEMENT PRÉVUE PAR LE FABRICANT PEUT ENDOMMAGER LE DISPOSITIF DE PROTECTION DE L'INSTRUMENT.

### **IMPIEGO**

QUALORA QUESTO STRUMENTO VENISSE UTILIZZATO IN MODO DIVERSO DA COME SPECIFICATO DAL PRODUTTORE LA PROZIONE DI SICUREZZA POTREBBE VENIRNE COMPROMESSA.

## **SERVICE**

SERVICING INSTRUCTIONS ARE FOR USE BY SERVICE - TRAINED PERSONNEL ONLY. TO AVOID DANGEROUS ELECTRIC SHOCK, DO NOT PERFORM ANY SERVICING UNLESS QUALIFIED TO DO SO.

## **SERVICIO**

LAS INSTRUCCIONES DE SERVICIO SON PARA USO EXCLUSIVO DEL PERSONAL DE SERVICIO CAPACITADO. PARA EVITAR EL PELIGRO DE DESCARGAS ELÉCTRICAS, NO REALICE NINGÚN SERVICIO A MENOS QUE ESTÉ CAPACITADO PARA HACERLO.

## **WARTUNG**

ANWEISUNGEN FÜR DIE WARTUNG DES GERÄTES GELTEN NUR FÜR GESCHULTES FACHPERSONAL. ZUR VERMEIDUNG GEFÄHRLICHE, ELEKTRISCHE SCHOCKS, SIND WARTUNGSARBEITEN AUSSCHLIEßLICH VON QUALIFIZIERTEM SERVICEPERSONAL DURCHZUFÜHREN.

## **ENTRETIEN**

L'EMPLOI DES INSTRUCTIONS D'ENTRETIEN DOIT ÊTRE RÉSERVÉ AU PERSONNEL FORMÉ AUX OPÉRATIONS D'ENTRETIEN. POUR PRÉVENIR UN CHOC ÉLECTRIQUE DANGEREUX, NE PAS EFFECTUER D'ENTRETIEN SI L'ON N'A PAS ÉTÉ QUALIFIÉ POUR CE FAIRE.

## **ASSISTENZA TECNICA**

LE ISTRUZIONI RELATIVE ALL'ASSISTENZA SONO PREVISTE ESCLUSIVAMENTE PER IL PERSONALE OPPORTUNAMENTE ADDESTRATO. PER EVITARE PERICOLOSE SCOSSE ELETTRICHE NON EFFETTUARRE ALCUNA RIPARAZIONE A MENO CHE QUALIFICATI A FARLA.

## **About This Manual**

---

This manual covers the operating and maintenance instructions for the following models:

4042E Series - Channel Power Sensors

## **Changes to this Manual**

---

We have made every effort to ensure this manual is accurate. If you discover any errors, or if you have suggestions for improving this manual, please send your comments to our Solon, Ohio factory. This manual may be periodically updated. When inquiring about updates to this manual refer to the part number and revision on the title page.

# TABLE OF CONTENTS

<b>Safety Precautions</b> .....	<b>i</b>
Safety Symbols .....	ii
Warning Statements .....	ii
Safety Statements .....	iii
<b>About This Manual</b> .....	<b>v</b>
Changes to this Manual .....	v
<b>Chapter 1 Introduction</b> .....	<b>1</b>
Purpose and Function .....	1
Channel Sensor Operation .....	3
Ethernet Measurement Interface .....	4
Ethernet IP Address .....	4
Password Protection .....	4
Push-To-Talk (PTT) .....	5
<b>Chapter 2 Power Sensor Installation</b> .....	<b>6</b>
Ethernet Connection .....	6
Direct PC Ethernet Connection .....	7
LAN Connection .....	7
RF Connections .....	9
PTT Connections .....	9
<b>Chapter 3 Sensor Operation</b> .....	<b>10</b>
User Interface .....	10
Table View .....	11
Settings Menu .....	13
RF Measurement Alarm Settings .....	13
Channel Configuration .....	16
SNMP Configuration .....	20
Configuration Menu .....	24



IP Address Configuration .....	24
NTP Settings .....	24
Update Sensor Firmware .....	25
Manage Users .....	26
Change Password .....	26
Reboot .....	27
About Screen .....	27
<b>Chapter 4 Maintenance .....</b>	<b>28</b>
Factory Reset .....	28
Customer Service .....	29
<b>Chapter 5 Specifications .....</b>	<b>30</b>
Model Identification .....	31
<b>Limited Warranty .....</b>	<b>32</b>

## Purpose and Function

---

The Bird 4042E Series Channel Power Sensors are digital power sensors. The 4042E Series Channel Power Sensors are typically used to measure forward and reflected average power on a 50 ohm RF transmission line in a frequency band with an overall range of 100 to 1000 MHz. There are two maximum forward power measurement options 50 or 500 watts with reflected power max 10 dB below the forward power levels, the 4042E sensor also provides VSWR readings. See "[Model Identification](#)" on page 31.

**Figure 1** Bird 4042E Sensor



The 4042E Power Sensor uses Ethernet communications for sensor control and measurement data.

See "[Sensor Operation](#)" on page 10.

The 4042E Sensor is designed to transfer data over an Ethernet connection. The power sensor requires an external power supply.

Each sensor is equipped with RF input and output connectors, one RJ-45 connector for Ethernet communications, a PTT connector, and a status indicator. See [Figure 2](#).

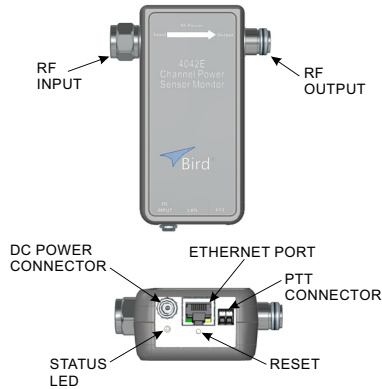
**Figure 2 Bird 4042E Series Channel Power Sensor**

<i>Features</i>	
RF Input	N-Type (male) connector (shown), other connector types available, see <a href="#">"Model Identification" on page 31</a>
RF Output	N-Type (female) connector (shown), other connector types available, see <a href="#">"Model Identification" on page 31</a>
DC Power Connector	DC input connector for the included 15 VDC power supply.
Ethernet Port	RJ-45 connector used to interface with the Sensor's Web UI and provide the measurement interface.
PTT Connector	Push-To-Talk terminal is used to prevent spurious alarms during periods when the transmitter is not transmitting, see <a href="#">"Push-To-Talk (PTT)" on page 5</a> .
Reset Button	This reset button is a hole under the Ethernet jack. <ul style="list-style-type: none"> <li>When short pressed (less than 5 seconds), the button will cause the IP address to be reset to the default of 192.168.3.200.</li> <li>When long pressed (more than 5 seconds), all of the 4042E settings are reset to the factory defaults.</li> </ul>
Status LED	Solid green: Power applied during boot-up. Blue flashing: Normal operation. Red: Reset button pressed and released.

## Channel Sensor Operation

The 4042E Channel Sensor is a unique sensor that is able to measure the forward power, reflected power and VSWR of a SINGLE CHANNEL in the presence of multiple channels at the output of a frequency combiner (see [Figure 5 on page 6](#)).

The sensor can also measure the forward power, reflected power and the VSWR of the composite signal by scanning up to 16 individual channels and summing their power, see [Figure 3](#).

**Figure 3 Channel Sensor Configuration**

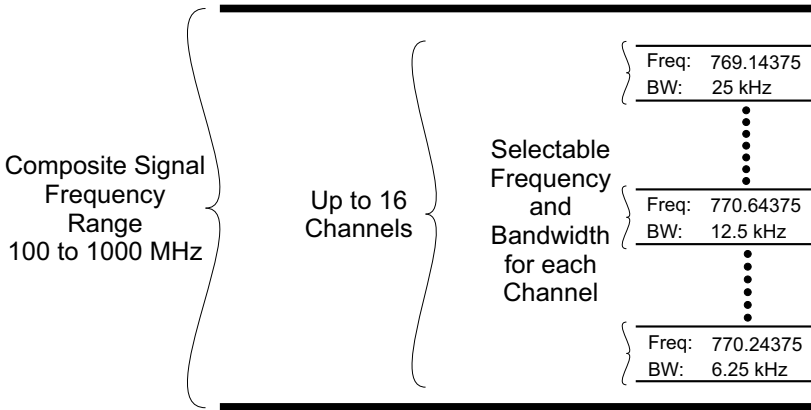

Once connected to an RF Transmission line, the sensor may be programmed to measure power and VSWR for up to 16 frequencies or channels.

The bandwidth of each channel is selectable and may be set to one of the following values:

- 6.25 kHz
- 12.5 kHz
- 25 kHz

The sensor can be setup to provide low power and VSWR alarms for all 16 channels monitored by the 4042E Sensor. See "[RF Measurement Alarm Settings](#)" on page 13.

## Ethernet Measurement Interface

The 4042E sensor displays measurement information on a Web UI. Using a web browser, enter the Ethernet IP Address for the 4042E to display the web page.

Table view displays the composite Forward, Reflected, and VSWR measurements and the same measurements for each configured channel. Sensor uptime and temperature are also displayed in table view. See [Figure 4](#).

**Figure 4 Web UI, Table View Measurement Display**

Table View		Settings		Bird 4042E RF Power Sensor		Logout admin	
<b>Sensor Name: 4042E</b>							
Forward	0.0 W						
Reflected	0.0 W						
VSWR	1.00						
Temperature	59.9 °C						
Uptime	0:00:23:31						
Channel Name	Forward Power	Reflected Power	VSWR	PTT State			
Channel 1	0.0 W	0.0 W	1.0	PTT Idle			
Channel 2	0.0 W	0.0 W	1.0	Disabled			

## Ethernet IP Address

Each 4042E leaves the factory with the same default IP Address.

Default IP Address: **192.168.3.200**

To change the IP address, see ["IP Address Configuration" on page 24](#).

## Password Protection

### NOTE

***Beginning with Application Version release 3.0 the Web UI configuration settings are password protected.***

The 4042E configuration settings are password protected. The sensor may not be configured without entering a password. The Web UI provides a user management menu, several users with individual passwords may be added.

Default username is **admin**.

Default admin password is the **Sensor's Serial Number**.

To change the password or add additional users, see ["Manage Users" on page 26](#).

## Push-To-Talk (PTT)

---

Push-To-Talk (PTT) is used to prevent false alarms during periods when the transmitter is not transmitting. When enabled, PTT prevents spurious alarms during periods when the transmitter is not transmitting because alarm functions will only be possible when the transmit button is engaged.

PTT may be set to normally open or normally closed logic. The PTT terminals must be in the correct logic state for PTT to operate correctly.

**NOTE**

***PTT input is a passive connection and requires a 5V TTL signal to operate.***

# CHAPTER 2 POWER SENSOR INSTALLATION

The Bird 4042E Series Channel Power Sensors are designed to be used for continuous power monitoring in multiple Land Mobile Radio (LMR) systems. The 4042E can provide real-time RF forward and reflected power and VSWR measurements.

## Ethernet Connection

The Ethernet connector is used to connect the 4042E to a PC or a network router/switch. Measurement data is transported over the Ethernet connection so the data can be viewed in a web browser. The configuration depicted in [Figure 5](#) is an example of one possible installation.

Since the 4042E is shipped with a static IP address, before more than one unit can be added to a LAN, the IP address must be changed to a unique static IP address or set to DHCP.

**Direct PC Connection** — A direct PC connection is a connection between a PC and a single 4042E. This connection can be used to view the sensor's measurement data, however, if the sensor will be used with a LAN connection, this type of connection must be used to change the IP address of the 4042E. See "[Direct PC Ethernet Connection](#)" on page 7.

**LAN Connection** — The 4042E may be connected to a router or switch so it can provide measurement information through a LAN. A LAN connection can provide the ability to monitor several 4042E sensors from a single PC. Additionally, SNMP management software can be used to aggregate multiple sensors and monitor their outputs. See "[LAN Connection](#)" on page 7.

**Figure 5 4042E Connection Diagram**

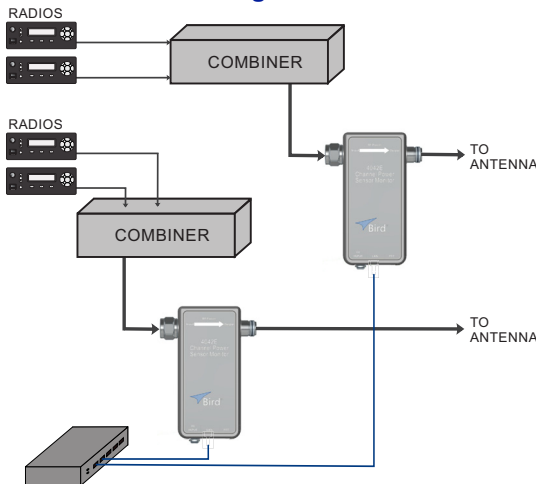

## Direct PC Ethernet Connection

---

This connection can be used to view measurement information, manage the sensor's behavior, and change the default IP address.

1. Connect a power cable to 4042E power sensor.
2. Connect your laptop's network port to the LAN connector on the 4042E using a standard Ethernet cable.
3. Ensure that your laptop's IP address is compatible with the default address of the 4042E. This may require changes be made to the Ethernet adapter address on your laptop.  
Set laptop's IP address to "192.168.3.1" and a subnet mask of "255.255.255.0".
4. Launch your web browser on the laptop.
5. In your web browser's address box, type-in the 4042E's IP address: 192.168.3.200 and press the ENTER key.
6. The web page interface to the unit should appear in your laptop's browser window.
7. Click Login in the top right of the display. See [Figure 6](#).
8. Enter User Name and Password. See [Figure 6](#) for default login information.

**Figure 6 Login Screen**

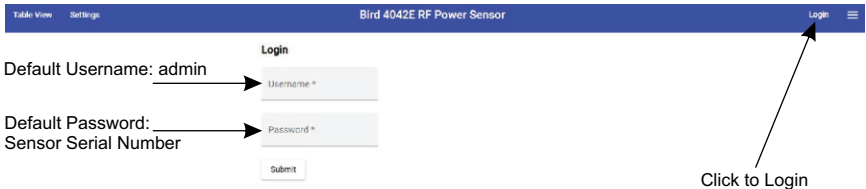

9. Connect sensor to RF delivery system. See ["RF Connections" on page 9](#).
10. If PTT will be used, see ["PTT Connections" on page 9](#).
11. See ["Sensor Operation" on page 10](#) for descriptions of the sensor's User Interface.

## LAN Connection

---

A LAN connection is used to allow multiple sensors to be deployed then monitored via a single PC or SNMP management software.

The 4042E sensor's IP address should be set to a unique static IP address or set to DHCP so the IP address can be assigned when the sensor is connected to the network.

1. Connect a power cable to 4042E power sensor.



2. Change sensor's IP Address.
  - a. Connect your laptop's network port to the LAN connector on the 4042E using a standard Ethernet cable.
  - b. Ensure that your laptop's IP address is compatible with the default address of the 4042E. This may require changes be made to the Ethernet adapter address on your laptop.  
Set laptop's IP address to "192.168.3.1" and a subnet mask of "255.255.255.0".
  - c. Launch your web browser on the laptop.
  - d. In your web browser's address box, type-in the 4042E's IP address: 192.168.3.200 and press the ENTER key.  
The web page interface to the unit should appear in your laptop's browser window.
  - e. Click Login in the top right of the display. See [Figure 6 on page 7](#).
  - f. Enter User Name and Password.
  - g. Click the  menu in the top right of the display. See [Figure 7](#).
  - h. Select Network Settings.
  - i. Select Static or DHCP.
    - If Static is selected, enter a unique IP address, Netmask, Gateway, then go to next step.
    - If DHCP is selected, go to next step.
  - j. Click Submit.
  - k. Disconnect Ethernet cable from the 4042E.

**Figure 7 IP Address Configuration**

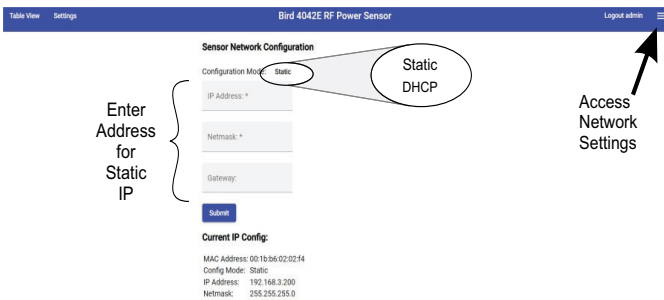

3. Connect a standard Ethernet cable to the LAN connector on the 4042E and an open connector on a network switch or router.
4. Launch your web browser on a PC connected to the same network as the 4042E.
5. Enter the sensor's newly assigned IP address in the web browser's address box.

6. If required, log in again with User Name and Password. See [Figure 6 on page 7](#) for default login information.
7. Connect sensor to RF delivery system. See "[RF Connections](#)" on [page 9](#).
8. If PTT will be used, see "[PTT Connections](#)" on [page 9](#).
9. See "[Sensor Operation](#)" on [page 10](#) for descriptions of the sensor's User Interface.

## RF Connections

---

### WARNING

**Leaking RF energy is a potential health hazard. Never attempt to connect or disconnect equipment from the transmission line while RF power is being applied. Severe burns, electrical shock, or death can occur.**

1. Disable RF power for transmission lines to be disconnected.
2. Connect combiner's RF output cable to the 4042E RF input.
3. Connect 4042E's RF output connector to the antenna cable.
4. Repeat step [1](#) through [3](#) for any additional 4042E Power Sensors.

RF Alarm Settings and Thresholds can be set for each RF Power Sensor, see "[RF Measurement Alarm Settings](#)" on [page 13](#).

## PTT Connections

---

PTT may be set to normally open or normally closed logic. The PTT terminals must be in the correct logic state for PTT to operate correctly.

### NOTE

***PTT input is a passive connection and requires a 5V TTL signal to operate.***

**Figure 8 PTT Connections**

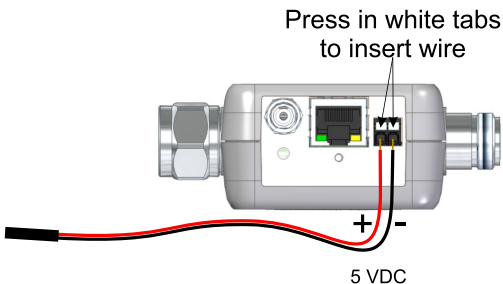

The PTT settings in the User Interface must be enabled and set to correct logic to match the PTT connection. See "[Channel Configuration](#)" on [page 16](#).

## User Interface

---

**Table View** — Table View page displays the RF measurements made by the 4042E. See "[Table View](#)" on page 11.

**NOTE**

*The following capabilities are password protected.*

**Settings Menu** — The [Settings Menu](#) is used for the following capabilities:

- RF Measurement Alarm Settings
- Channel Configuration
- SNMP Configuration

**Configuration Menu** — The [Configuration Menu](#)  is used for the following capabilities:

- IP Address Configuration
- NTP Settings
- Update Sensor Firmware
- Manage Users
- Change Password

## Table View

Table view shown in [Figure 9](#) displays the current RF Power Measurements.

- Sensor Name
- Forward RF Power ([Aggregate Forward Power](#) of all channels)
- Reflected RF Power ([Aggregate Reflected Power](#) of all channels)
- VSWR ([Aggregate VSWR](#))
- Each Configured Channel displays the following:
  - Forward Power
  - Reflected Power
  - VSWR
  - PTT State

Also displayed are sensor temperature and sensor uptime.

**Aggregate Forward Power** — Aggregate forward power is defined as the total sum of the forward power on all actively transmitting channels. A channel is transmitting when PTT is enabled and active, or PTT is disabled and the forward power of the channel exceeds the minimum forward power threshold.

**Aggregate Reflected Power** — Aggregate reflected power is defined as the total sum of the reflected power on all actively transmitting channels. A channel is transmitting when PTT is enabled and active, or PTT is disabled and the forward power of the channel exceeds the minimum forward power threshold.

**Aggregate VSWR** — Aggregate VSWR is calculated based on the aggregate forward power and aggregate reflected power.

**Figure 9 Web UI, Table View Measurement Display**

Table View		Settings			Bird 4042E RF Power Sensor		Logout admin	
<b>Sensor Name: 4042E</b>								
Forward	0.0 W ⓘ							
Reflected	0.0 W ⓘ							
VSWR	1.00 ⓘ							
Temperature	59.9 °C							
Uptime	0:00:23:31							
Channel Name	Forward Power	Reflected Power	VSWR	PTT State				
Channel 1	0.0 W	0.0 W	1.0	PTT Idle				
Channel 2	0.0 W	0.0 W	1.0	Disabled				

The table view information may also be accessed using SNMP software. [Table 1](#) displays the SNMP commands available for the aggregate Table View information.

**Table 1 SNMP Aggregate RF Power Commands**

Name	OID	Access Level	Description
sensor4042EName	21581.1.7.300.1	read-write	Name assigned to sensor. The sensor name may be set using a maximum of 20 characters.
sensor4042EForwardPower	21581.1.7.300.14	read-only	Aggregate forward power across all transmitting channels. Return value is in tenths, a return of 40 is 4 Watts.
sensor4042EReflectedPower	21581.1.7.300.15	read-only	Aggregate reflected power across all transmitting channels. Return value is in tenths, a return of 4 is 0.4 Watts.
sensor4042EVSWR	21581.1.7.300.16	read-only	Aggregate VSWR across all transmitting channels. Return value is in hundredths, a return of 110 is a VSWR of 1.1.
sensor4042ETemperature	21581.1.7.300.30	read-only	Internal Sensor Temperature in Celsius. Return value is in tenths, a return of 475 is an internal temp of 47.5° C
sensor4042EUpTime	21581.1.7.300.27	read-only	Time accumulated since power was applied or since the last reboot.

The channel information in the table view may also be accessed using SNMP management software. [Table 2](#) displays the SNMP commands available for each of the digital channels programmed into the 4042E.

**Table 2 SNMP Channel RF Power Commands**

Name	OID	Access Level	Description
digitalChannelName	21581.1.7.320.1.2	read-create	Name assigned to channel. Channel name may be set using a maximum of 20 characters.
digitalChannelForwardPower	21581.1.7.320.1.19	read-only	Channel Forward power. Return value is in tenths, a return of 40 is 4 Watts.
digitalChannelReflectedPower	21581.1.7.320.1.20	read-only	Channel Reflected power. Return value is in tenths, a return of 40 is 4 Watts.
digitalChannelVSWR	21581.1.7.320.1.21	read-only	Channel VSWR. Return value is in hundredths, a return of 110 is a VSWR of 1.1.
digitalChannelPTTState	21581.1.6.300.1.18	read-only	PTT state 1 = inactive 2 = active

## Settings Menu

### RF Measurement Alarm Settings

The 4042E power sensor can be set to display an alarm, and send SNMP trap messages, for exceeding forward power and VSWR limits set by the user.

Alarms are controlled on the settings page, see [Figure 10](#). There are Aggregate Signal Alarm Settings and alarm settings for each configured channel, see "[Channel Edit Pane](#)" on [page 16](#).

**Figure 10 4042E Alarm Settings**

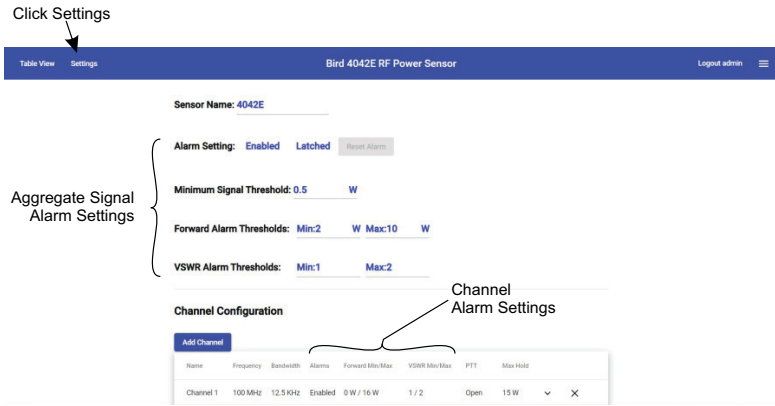

### Aggregate Signal Alarm Settings

[Figure 11 on page 14](#) shows the aggregate signal alarm settings

**Alarm Setting** — The alarm function may be enabled or disabled.

When enabled, a measurement exceeding the specified thresholds will display an alarm message in the Table View, see [Figure 12 on page 14](#).

When disabled, alarms are not displayed and no SNMP traps will be generated.

**Latching** — The alarms can be set to latched or unlatched.

When set to latched, alarm messages remain on the display until the Reset Alarm button is clicked on the settings page.

When set to unlatched, alarm messages are only displayed while the threshold is exceeded.

#### NOTE

**Minimum Signal Threshold is disabled when PTT is enabled.**

**Minimum Signal Threshold** — Forward power must exceed this setting for alarm conditions to be evaluated when the Push-to-Talk (PTT) feature is disabled. Adjust this threshold to ensure background noise or weak signals do not trigger an alarm condition.

**Forward RF/VSWR Thresholds** — Thresholds for Forward RF alarms and VSWR alarms. Thresholds may be set to generate alarms for minimum and maximum values.

**Figure 11 Aggregate Signal Alarm Settings**

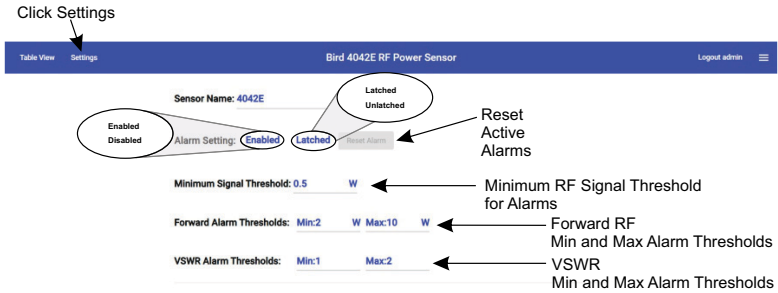

**NOTE**

**Alarm messages may remain on the display even if the alarm setting is unlatched under the following circumstances:**  
**When PTT is enabled, if an alarm is active when PTT transitions from active to idle.**  
**When PTT is disabled, if an alarm is active when the transmitter is deactivated.**

**Figure 12 Alarm Display**

Forward 0.0 W **Max Alarm**  
 Reflected 0.0 W  
 VSWR 1.00 **Max Alarm**

**Table 3 SNMP Aggregate Signal Alarm Settings Commands**

Name	OID	Access Level	Description
sensorAlarmEnable	21581.1.7.300.17	read-write	Master setting to enable/disable alarms. 1 = Set alarms to disabled 2 = Set alarms to enabled.
sensorAlarmMode	21581.1.7.300.18	read-write	Set alarms to latch until manually reset. 1 = Set alarms to latched 2 = Set alarms to unlatched
sensorResetAlarms	21581.1.7.300.19	read-write	2 = Set to reset all active alarms. Get always returns 0.
sensorMinSignalThreshold	21581.1.6.300.33	read-write	Sets minimum signal threshold for the sensor. Signals below this threshold will not trigger an alarm. Threshold in hundredths, an entry of 5 would be 0.05 Watts.

sensor4042EMinPowerLimit	21581.1.7.300.8	read-write	Sets minimum power threshold for the sensor. Power below this value will result in an alarm. Power is the aggregate power measurement for all transmitting channels. Threshold in tenths, an entry of 40 would be 4 Watts.
sensor4042EMaxPowerLimit	21581.1.7.300.10	read-write	Set maximum power threshold for the sensor. Power above this value will result in an alarm. Power is the aggregate power measurement for all transmitting channels. Threshold in tenths, an entry of 40 would be 4 Watts.
sensor4042EMinVSWRLimit	21581.1.7.300.4	read-write	Set minimum VSWR threshold for the sensor. VSWR below this value will result in an alarm. VSWR is computed using aggregate power measurements for all transmitting channels. Threshold in hundredths, an entry of 110 is a VSWR of 1.1.
sensor4042EMaxVSWRLimit	21581.1.7.300.6	read-write	Set maximum VSWR threshold for the sensor. VSWR above this value will result in an alarm. VSWR is computed using aggregate power measurements for all transmitting channels. Threshold in hundredths, an entry of 110 is a VSWR of 1.1.
sensor4042EMinPowerAlarm	21581.1.7.300.9	read-only	Indicates whether alarm has occurred for power below limit. 1- inactive (no alarm) 2 - active (alarm) Power is the aggregate power measurement for all transmitting channels.
sensor4042EMaxPowerAlarm	21581.1.7.300.11	read-only	Indicates whether alarm has occurred for power above limit. 1- inactive (no alarm) 2 - active (alarm) Power is the aggregate power measurement for all transmitting channels.
sensor4042EMinVSWRALarm	21581.1.7.300.5	read-only	Indicates whether alarm has occurred for VSWR below limit. 1- inactive (no alarm) 2 - active (alarm) VSWR is computed using aggregate power measurements for all transmitting channels.
sensor4042EMaxVSWRALarm	21581.1.7.300.7	read-only	Indicates whether alarm has occurred for VSWR above limit. 1- inactive (no alarm) 2 - active (alarm) VSWR is computed using aggregate power measurements for all transmitting channels.



## Channel Configuration

The 4042E sensor is capable of scanning up to 16 individual channels. Each channel must be configured.

To add a channel, click the **Add Channel** button. See [Figure 13](#).

To configure a channel, click the **down arrow** to the right of the displayed channel information.

To delete a channel, click the **X** to the right of the displayed channel information.

**Figure 13 Channel Configuration**

Click Settings

The screenshot shows the 'Channel Configuration' page for the 'Bird 4042E RF Power Sensor'. At the top, there are tabs for 'Table View' and 'Settings', and a 'Logout admin' link. Below the tabs is a table with columns: Name, Frequency, Bandwidth, Alarms, Forward Min/Max, VSWR Min/Max, PTT, and Max Hold. Two channels are listed: Channel 1 (450 MHz, 12.5 KHz, Enabled, 0 W / 16 W, 1 / 2, Closed, 15 W) and Channel 2 (118 MHz, 25 KHz, Enabled, 0 W / 500 W, 1 / 50, Disabled, 100 W). Annotations include: 'Click here to add a channel' pointing to the 'Add Channel' button; 'Click here to expand the channel edit pane' pointing to the down arrow in the 'Max Hold' column for Channel 1; and 'Click here to delete the associated channel' pointing to the 'X' icon in the 'Max Hold' column for Channel 1.

## Channel Edit Pane

The Channel Edit Pane ([Figure 14](#)) is used to enter the settings for each channel you wish to monitor. Click the down arrow as shown in [Figure 13](#), to display the Channel Edit Pane.

**Figure 14 Channel Edit Pane**

Channel 1	450 MHz	12.5 KHz	Enabled	0 W / 16 W	1 / 2	Closed
Channel Name *	Bandwidth:	Frequency: *	Channel Alarm:			
Channel 1	12.5 KHz	450 MHz	Enabled			
Forward Min: *	Forward Max: *	VSWR Min: *	VSWR Max: *			
0 W	16 W	1	2			
Max Hold Threshold:	Forward Threshold: *	PTT Mode:				
Enabled	15 W	Normally Closed				

- Channel Name: If desired, rename the channel using a name that will indicate relevant system information. Maximum of 20 characters.
- Bandwidth Setting: Select the bandwidth of the selected channel. Options are 6.25, 12.5 and 25 kHz.
- Frequency: Enter the frequency in MHz of the channel to monitor. Minimum of 100 MHz and maximum of 1000 MHz.

- Channel Alarm: If alarm monitoring of the selected channel is desired select Enabled option for channel alarm. Disabled is the default selection, meaning alarms are not monitored for the selected channel. This alarm does not effect the composite power alarm shown in ["Aggregate Signal Alarm Settings" on page 13](#).
  - ◆ Forward Min Alarm Setting: Lower limit forward measured power must reach to cause alarm condition.  
The Forward Alarm threshold can range from 0 to 10000 Watts.
  - ◆ Forward Max Alarm Setting: Upper limit forward measured power must reach to cause alarm condition.
  - ◆ VSWR Min Alarm Setting: Lower limit VSWR measurement must reach to cause alarm condition.  
VSWR Alarm threshold may be set from 1 (no Alarm) to 100.
  - ◆ VSWR Max Setting: Upper limit VSWR measurement must reach to cause alarm condition.
- Max Hold Threshold: The Forward Power Sample is a capability to provide a max hold sample of an RF signal exceeding a specified threshold. When enabled, a forward power measurement exceeding the threshold will cause the sensor to save the maximum power (forward and reflected) and maximum VSWR measured while the threshold is exceeded, see [Figure 14 on page 16](#). When disabled, max values are not saved. The max hold samples must be requested via SNMP, the values are not available in the 4042E's table view, see [Table 6 on page 19](#) for SNMP commands.
- Forward Threshold: This value sets the threshold for max hold sample.
- PTT Mode: Push to Talk, default is Disabled. Enabled options are Normally Open and Normally Closed logic.

**NOTE**

***Only one channel should be enabled for PTT. There is only one physical connection for PTT wiring.***

**Table 4 SNMP Digital Channel Settings Commands**

Name	OID	Access Level	Description
digitalChannelAdd	21581.1.7.321	read-write	Add a channel to the Channel Table
digitalChannelIndex	21581.1.7.320.1.1	accessible-for-notify	Unique index for channel.
digitalChannelRemove	21581.1.7.320.1.26	read-create	Remove a channel from the channel table. 1 = remove
digitalChannelName	21581.1.7.320.1.2	read-create	Name assigned to channel. Channel name may be set using a maximum of 20 characters.

digitalChannelBandwidthSelect	21581.1.7.320.1.15	read-create	Bandwidth of channel. 1 = 25 KHz BW 2 = 12.5 KHz BW 3 = 6.25 KHz BW
digitalChannelFrequencyHz	21581.1.7.320.1.14	read-create	Center frequency of channel in Hz. Range 100000000 to 1000000000
digitalChannelAlarmEnable	21581.1.7.320.1.3	read-create	Enable/disable alarms for this channel. 1 = Disabled 2 = Enabled
digitalChannelMinPowerLimit	21581.1.7.320.1.10	read-create	Minimum forward power alarm limit for the channel. Power below this value will result in an alarm. Threshold in tenths, an entry of 40 would be 4 Watts.
digitalChannelMaxPowerLimit	21581.1.7.320.1.12	read-create	Maximum forward power alarm limit for the channel. Power above this value will result in an alarm. Threshold in tenths, an entry of 40 would be 4 Watts.
digitalChannelMinVSWRLimit	21581.1.7.320.1.6	read-create	Minimum VSWR alarm limit for the channel. VSWR below this value will result in an alarm. Threshold in hundredths, an entry of 110 is a VSWR of 1.1.
digitalChannelMaxVSWRLimit	21581.1.7.320.1.8	read-create	Maximum VSWR alarm limit for the channel. VSWR above this value will result in an alarm. Threshold in hundredths, an entry of 110 is a VSWR of 1.1.
digitalChannelMaxHoldEnable	21581.1.7.320.1.4	read-create	Enable/disable channel max threshold. 1 = Disabled 2 = Enabled
digitalChannelMaxHoldThreshold	21581.1.7.320.1.5	read-create	Maxhold threshold for this channel. Power above this value will be stored on the sensor. Threshold in tenths, an entry of 40 would be 4 Watts.
digitalChannelPTTType	21581.1.7.320.1.16	read-create	PTT type: 1 = Disabled 2 = Normally-Open 3 = Normally-Closed

**Table 5 SNMP Digital Channel RF Power/VSWR GET commands**

Name	OID	Access Level	Description
digitalChannelMinPowerAlarm	21581.1.7.320.1.11	read-only	Indicates whether alarm has occurred for power below limit. 1 = Inactive 2= Active
digitalChannelMaxPowerAlarm	21581.1.7.320.1.13	read-only	Indicates whether alarm has occurred for power above limit. 1 = Inactive 2= Active
digitalChannelMinVSWRAlarm	21581.1.7.320.1.7	read-only	Indicates whether alarm has occurred for VSWR below limit. 1 = Inactive 2= Active
digitalChannelMaxVSWRAlarm	21581.1.7.320.1.9	read-only	Indicates whether alarm has occurred for VSWR above limit. 1 = Inactive 2= Active

**Table 6 SNMP Digital Channel Sample Max Hold GET commands**

Name	OID	Access Level	Description
digitalChannelForwardMaxHold	21581.1.7.320.1.22	read-only	Forward Power Max Hold. Return value is in tenths, a return of 40 is 4 Watts.
digitalChannelReflectedMaxHold	21581.1.7.320.1.23	read-only	Reflected Power Max Hold. Return value is in tenths, a return of 4 is 0.4 Watts.
digitalChannelVSWRMaxHold	21581.1.7.320.1.24	read-only	VSWR Max Hold. Return value is in hundredths, a return of 110 is a VSWR of 1.1.
digitalChannelMaxHoldTime	21581.1.7.320.1.25	read-only	Time the latest max hold values were recorded. Network Time Protocol (NTP) should be configured for this value to be meaningful. See " <a href="#">NTP Settings</a> " on page 24.

**Table 7 SNMP Digital Channel PTT GET commands**

Name	OID	Access Level	Description
digitalChannelPTTState	21581.1.7.320.1.18	read-only	PTT state. 1 = Inactive 2= Active

---

## SNMP Configuration

---

The Simple Network Management Protocol (SNMP) feature is designed to provide reliable Internet notification of an alarm occurrence. SNMP is an Internet standard protocol for managing devices on IP networks.

SNMP network management software is required to implement SNMP. It is the customer's responsibility to ensure the destination computer is running suitable SNMP management software.

Bird provides MIB files for use with the customer's SNMP management software. These MIB files allow the trap messages to be properly decoded. The MIB files can be downloaded from the product page on the Bird website at; "www.birdrf.com".

The 4042E supports SNMP GET and SET commands, and can be configured to send SNMP Trap messages. All of the 4042E's SNMP commands can be found in the MIB file.

### GET and SET Commands

The SNMP manager can issue a GET request to read settings and power measurements, and the SNMP manager can issue a SET request to change settings.

The 4042E SNMP Configuration includes Read, Write, and Trap community strings. The SNMP Agent community strings must match the 4042E community strings to successfully perform gets and sets. See [Figure 15 on page 21](#).

#### GETS

The SNMP GET operation is used by the SNMP manager applications to retrieve one or more values from the 4042E.

The SNMP GET operation is used to query the scalar variables in a MIB. Each variable is identified by its OID. The 4042E will respond with a return value or with an error.

#### SETS

The SNMP SET operation is used by the SNMP manager to modify settings in the 4042E.

Perform an SNMP SET operation by providing the host name of the 4042E, one or more OIDs along with its instance, and the new value. The 4042E processes the request and assigns the new value to the MIB variable. If an error occurs, the new value is not assigned.

SNMP Sets must be enabled in the UI under SNMP Configuration, see [Figure 15 on page 21](#). If SNMP Sets are disabled, an SNMP set operation will return a "Commit failed" error, the SNMP agent will not be able to send any SET commands, and no settings can be changed from the SNMP Manager.

**Figure 15 SNMP Configuration**

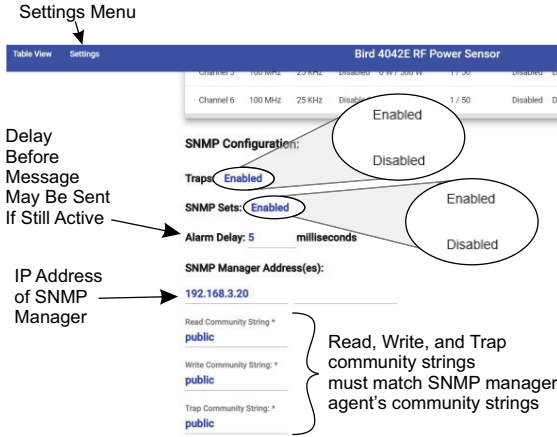

**Table 8 SNMP Configuration Commands**

Name	OID	Access Level	Description
sensorTrapsEnable	21581.1.7.300.21	read-write	Enable/disable all traps. 1 = Disabled 2 = Enabled
sensorAlarmDelay	21581.1.7.300.20	read-write	Alarm delay set in milliseconds.
snmpTargetIP	21581.1.7.330.1.2	read-write	IP address for one trap receiver target, in standard format (###.###.###.###).
snmpTargetIPIndex	21581.1.7.330.1.1	read-only	Unique index for IP target entry.

**SNMP Traps**

**NOTE**

*Traps may be enabled and disabled using the UI or SNMP.*

Traps are messages sent to the SNMP manager by the 4042E when events occur.

**NOTE**

***Do not enter duplicate SNMP IP addresses. Duplicate IP addresses entered into SNMP Manager Address fields will cause duplicates of SNMP messages sent to an SNMP server.***

To enable SNMP Trap functionality, connect to the 4042E User Interface, enable Traps, and enter the SNMP Manager’s IP address. See [Figure 9](#). Up to 6 SNMP IP addresses may be added. IP addresses may be set on the UI or via the SNMP manager.

A trap message will be sent to designated host computers whenever the sensor detects an alarm condition. See [Table 9 on page 22](#).

Table 9 SNMP Trap Message Definitions

Name	OID	Message	Description
minAggregateVswrAlarmTrap	21581.1.7.0.1	sensor4042EName, sensor4042EMinVSWR Limit, sensor4042EMinVSWR Alarm, sensor4042EVSWR	Alarm that occurs when the aggregate VSWR is below the minimum VSWR setting.
maxAggregateVswrAlarmTrap	.21581.1.7.0.2	sensor4042EName, sensor4042EMaxVSWR Limit, sensor4042EMaxVSWR Alarm, sensor4042EVSWR	Alarm that occurs when the aggregate VSWR is above the maximum VSWR setting.
minAggregateFwdPowerAlarm Trap	21581.1.7.0.3	sensor4042EName, sensor4042EMinPower Limit, sensor4042EMinPower Alarm, sensor4042EForward Power	Alarm that occurs when the aggregate Forward Power is below the minimum power setting.
maxAggregateFwdPowerAlarm Trap	21581.1.7.0.4	sensor4042EName, sensor4042EMaxPower Limit, sensor4042EMaxPower Alarm, sensor4042EForward Power	Alarm that occurs when the aggregate Forward Power is above the maximum power setting.
minChannelVswrAlarmTrap	21581.1.7.0.5	sensor4042EName, digitalChannelIndex, digitalChannelName, digitalChannelMinVSWR Limit, digitalChannelMinVSWR Alarm, digitalChannelVSWR	Alarm that occurs when a channel's VSWR is below the minimum VSWR alarm limit set for that channel.
maxChannelVswrAlarmTrap	21581.1.7.0.6	sensor4042EName, digitalChannelIndex, digitalChannelName, digitalChannelMaxVSWR Limit, digitalChannelMaxVSWR Alarm, digitalChannelVSWR	Alarm that occurs when a channel's VSWR is above the maximum VSWR alarm limit set for that channel.
minChannelFwdPowerAlarm Trap	21581.1.7.0.7	sensor4042EName, digitalChannelIndex, digitalChannelName, digitalChannelMinPower Limit, digitalChannelMinPower Alarm, digitalChannelForward Power	Alarm that occurs when a channel's forward power is below the minimum forward power alarm limit set for that channel.

maxChannelFwdPowerAlarm Trap	21581.1.7.0.8	sensor4042EName, digitalChannelIndex, digitalChannelName, digitalChannelMaxPowerLimit, digitalChannelMaxPowerAlarm, digitalChannelForwardPower	Alarm that occurs when a channel's forward power is above the maximum forward power alarm limit set for that channel.
pttTrap	21581.1.7.0.9	sensor4042EName, digitalChannelIndex, digitalChannelName, digitalChannelPTTIndex, digitalChannelPTTType, digitalChannelPTTState, digitalChannelForwardPower, digitalChannelReflectedPower, digitalChannelVSWR	Trap sent when PTT state changes.

### SNMP Sets

SNMP Sets must be enabled in the UI under SNMP Configuration, see [Figure 15 on page 21](#). If SNMP Sets are disabled, the SNMP agent will not be able to send any SET commands, and no settings can be changed from the SNMP Manager.

**NOTE**

*When SNMP Sets are disabled in the Web UI, performing an SNMP set operation will return a “Commit failed” error.*

### Alarm Delay

The alarm delay can be used to eliminate transient alarms by delaying SNMP trap messages and Web UI alarm indications. If during the delay, the threshold condition is no longer valid, a trap message will not be generated, and no indication will appear on the Web UI.

If SNMP trap messages are disabled, when an alarm threshold condition is met, an alarm message will be displayed on the Web UI only.

If SNMP trap messages are enabled, when an alarm threshold condition is met, a message will be sent to the SNMP manager, and an alarm message will be displayed on the Web UI.

The alarm delay can be set using the UI or SNMP. The maximum delay is 10000 milliseconds (10 seconds). See [Table 8 on page 21](#).

### Community Strings

The SNMP community strings are like a user ID or password that allows access to the sensor’s data and configuration. The community strings default to public, meaning they are open and may be accessed by any SNMP client.

To protect the sensor’s data and configuration, the community strings may be changed so only a client with matching strings may access the sensor’s data and configuration. The community strings can only be changed using the UI.

The 4042E allows setting the following community strings: **Read, Write, Traps**.



## Configuration Menu

### IP Address Configuration

The sensor's IP Address should be changed if the 4042E sensor will be used on a LAN, especially if more than one sensor is deployed. Each device on a network must have a unique IP address.

The 4042E sensor may be set to use a Static IP address or set to DHCP and assigned an IP address. If Static is chosen, a unique IP address and netmask must be entered into the fields on the Sensor Network Configuration Screen.

**Figure 16 IP Address Configuration Screen**

### NTP Settings

The Network Time Protocol (NTP) is used by hundreds of millions of computers and devices to synchronize their clocks over the Internet.

The 4042E sensor may be configured to use a specific NTP server by entering the NTP Server's URL on the NTP Configuration page and clicking **Submit**.

**Figure 17 NTP Configuration**

## Update Sensor Firmware

The 4042E sensor’s functionality is enabled by firmware installed on the sensor. This firmware can be updated by accessing the firmware update utility on the 4042E sensor’s User Interface webpage. Firmware updates are designed to load completely without user interaction at the installation site.

To update firmware:

1. Download the firmware from the product page on the Bird website at; “www.birdrf.com”.
2. Click the  menu on the right side of the 4042E’s UI webpage to access the firmware update utility.
3. Click the **Upload File** button on the firmware update utility and navigate to the downloaded file.
4. Click **Apply** button when the “Apply Update?” dialog is displayed.
5. Wait until “Update Successful” dialog box is displayed, then click the **Refresh** button.

### NOTE

***Firmware updates are designed to load completely without user interaction at the installation site. Connection speeds to remote sites may delay upload and application. In the event of failure, the sensor will maintain its original firmware. Should this occur, simply re-start the update process.***

### NOTE

***The 4042E will reboot during the firmware update, the IP address must be the same following the reboot to ensure the Web UI will be accessible following the firmware update. If network Configuration Mode is set Static, the IP address will be the same following reboot. If network Configuration Mode is set to DHCP, the DHCP server should be configured to always assign the same IP address to the 4042E.***

**Figure 18 Firmware Update Utility**

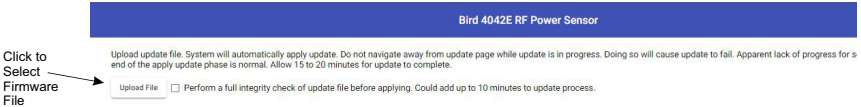

## Manage Users

The Manage Users option is available to manage user passwords. Multiple usernames with passwords may be added. The default admin username cannot be changed but the password should be changed from the default.

**Figure 19 Manage Users**



## Add User

To add a user, click . Enter a user name. Each username must be unique.

User Permissions are Standard or Administrator.

Administrator privileges have no restrictions, and may change any 4042E settings.

Standard User privileges allow the user to only change RF settings such as enabling/disabling alarms, setting thresholds, and change their own password. Standard User privileges prevent the user from making any changes to user accounts, SNMP, the IP Address, NTP servers, or update firmware.

**Figure 20 Adding User**

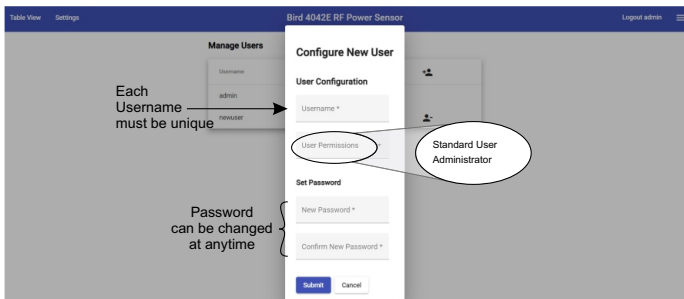

## Change Password

Users may use the change password option in the configuration menu to change the password for their account.

**Figure 21 Change Password**

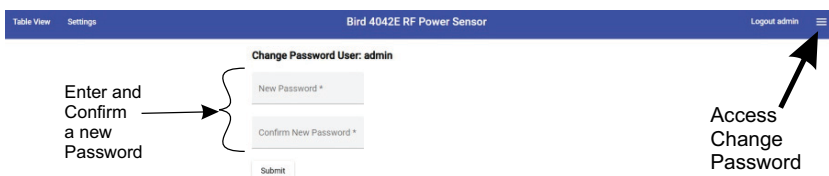

## Reboot

The 4042E User Interface includes an option to reboot the sensor. This allows the sensor to be rebooted from a remote location. This avoids the need to physically disconnect the sensor from its power source.

**Figure 22 Reboot Sensor**

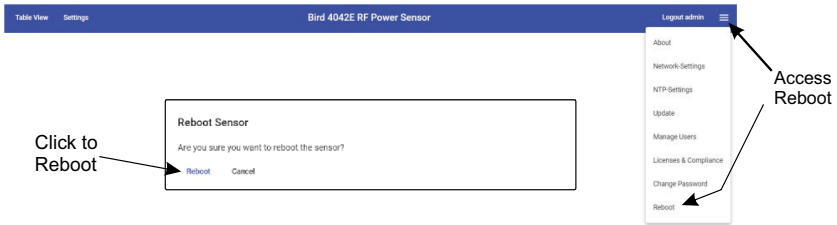

## About Screen

The About screen displays information about the 4042E sensor, including model number, serial number, calibration date, and software versions.

The information on the About screen may also be accessed using SNMP.

**Figure 23 About Screen**



**Table 10 SNMP Sensor Information**

Name	OID	Access Level	Description
sensor4042EModel	21581.1.7.300.2	read-only	Model number of sensor.
sensor4042ESerialNumber	21581.1.7.300.3	read-only	Serial number of sensor.
sensor4042ECalDate	21581.1.7.300.31	read-only	Calibration date of sensor.
firmwareVersion	21581.1.7.522	read-only	Firmware Version running on 4042E. Equivalent to Build Version on the About screen.
sensor4042EApplicationVersion	21581.1.7.300.32	read-only	Sensor Measurement Application version.

## Factory Reset

---

The 4042E includes a reset button which can be used for resetting the unit's IP address and other settings. The reset button is recessed in a hole on the bottom of the unit near the Ethernet jack, see [Figure 24](#).

Power must be applied to the 4042E to perform either of the following reset options.

### Reset IP Address

Press and release the button to reset the IP Address, the Status LED will briefly change to red. The IP address will be reset to the default of 192.168.3.200.

### Reset All Settings

Press and hold the reset button for a minimum of 5 seconds, then release the button, the Status LED will flash red five times to indicate all settings are being reset. All of the 4042E settings will be reset to the factory defaults. The reset will take approximately 30 seconds to complete.

**Figure 24** *Factory Reset*

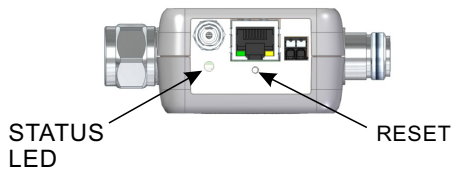

Contact the Bird Service Center in the event the power sensor requires additional maintenance. See ["Customer Service" on page 29](#).

## Customer Service

---

Any maintenance or service procedure beyond the scope of those in this chapter should be referred to a qualified service center.

If the unit needs to be returned for any reason, request an Return Material Authorization (RMA) through the Bird Technologies website. All instruments returned must be shipped prepaid and to the attention of the RMA number.

### **Bird Service Center**

30303 Aurora Road  
Cleveland (Solon), Ohio 44139-2794  
Fax: (440) 248-5426  
E-mail: [bsc@birdrf.com](mailto:bsc@birdrf.com)

For the location of the Sales Office nearest you, visit our Web site at:

<http://www.birdrf.com>

<i>Specification</i>	<i>Value</i>
Measurement Type	In-Line, Directional RF True Average Power by Channel, or Composite Power (by scanning channels)
Channel Bandwidth	6.25, 12.5, 25 kHz selectable
Frequency Range	100 to 1000 MHz
Forward Power Measurement	10W to 500W Single Channel or Composite Forward Average Power
Reflected Power Measurement	1W to 50W Single Channel or Composite Reflected Average Power
RF Connectors Input Output	Type-N (male), Type 4.3-10 (male) Type-N (female), Type 4.3-10 (female)
Impedance	50 Ohms nominal
Insertion Loss (Max.)	0.2 dB
Insertion VSWR (Max.)	1.15
Peak/Average Ratio (Max.)	12 dB
Directivity	25 dB minimum
Measurement Accuracy	± 5% of reading
Data Interfaces	Ethernet 10/100/1000BASE-T (auto-sense) Version 2.0/IEEE 802.3
RS-485 Data Interface Connector	RJ-45
PTT	Push-to-talk input, TTL levels, <15mA Pin 1 = V+; NO or NC logic (software selectable)
Power Requirement DC Power Jack External P.S.	5.5-40 VDC, 3W max. 0.08" (2mm) power jack 15V AC adapter included
Operating Temperature Range	0° C to +50° C (32° F to 122° F)
Storage Temperature Range	-40° C to +80° C (-40° F to 176° F)
Humidity	95% maximum (non-condensing)
Altitude (Max.)	15,000 ft. (4600 m)
Weight (Approx.)	0.6 lb. (0.27 kg)
Dimensions, Nominal Without Connectors	5.4" L x 3.8" W x 1.4" H (137.0 mm x 97 mm x 36 mm)
Operating Position	Any

## Model Identification

**NOTE**

*The Model Identification guide is provided to allow existing model numbers to be understood. However, not all combinations may be available. Please contact Bird for more information on new model number requests.*

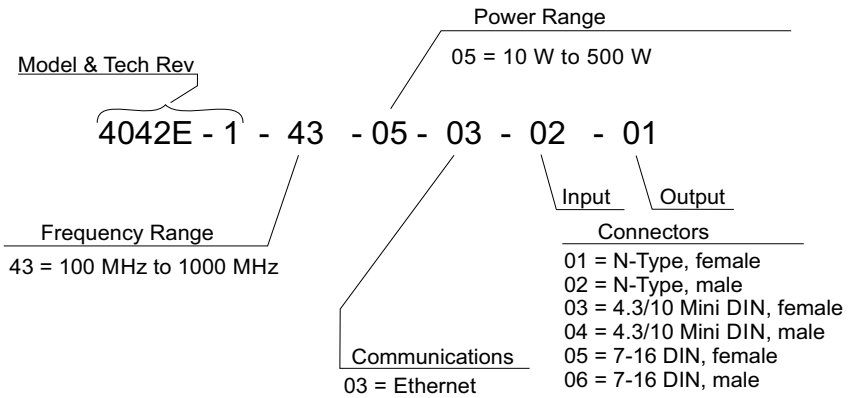



# Limited Warranty

All products manufactured by Seller are warranted to be free from defects in material and workmanship for a period of one (1) year, unless otherwise specified, from date of shipment and to conform to applicable specifications, drawings, blueprints and/or samples. Seller's sole obligation under these warranties shall be to issue credit, repair or replace any item or part thereof which is proved to be other than as warranted; no allowance shall be made for any labor charges of Buyer for replacement of parts, adjustment or repairs, or any other work, unless such charges are authorized in advance by Seller.

If Seller's products are claimed to be defective in material or workmanship or not to conform to specifications, drawings, blueprints and/or samples, Seller shall, upon prompt notice thereof, either examine the products where they are located or issue shipping instructions for return to Seller (transportation-charges prepaid by Buyer). In the event any of our products are proved to be other than as warranted, transportation costs (cheapest way) to and from Seller's plant, will be borne by Seller and reimbursement or credit will be made for amounts so expended by Buyer. Every such claim for breach of these warranties shall be deemed to be waived by Buyer unless made in writing within ten (10) days from the date of discovery of the defect.

The above warranties shall not extend to any products or parts thereof which have been subjected to any misuse or neglect, damaged by accident, rendered defective by reason of improper installation or by the performance of repairs or alterations outside of our plant, and shall not apply to any goods or parts thereof furnished by Buyer or acquired from others at Buyer's request and/or to Buyer's specifications. Routine (regularly required) calibration is not covered under this limited warranty. In addition, Seller's warranties do not extend to the failure of tubes, transistors, fuses and batteries, or to other equipment and parts manufactured by others except to the extent of the original manufacturer's warranty to Seller.

The obligations under the foregoing warranties are limited to the precise terms thereof. These warranties provide exclusive remedies, expressly in lieu of all other remedies including claims for special or consequential damages. SELLER NEITHER MAKES NOR ASSUMES ANY OTHER WARRANTY WHATSOEVER, WHETHER EXPRESS, STATUTORY, OR IMPLIED, INCLUDING WARRANTIES OF MERCHANTABILITY AND FITNESS, AND NO PERSON IS AUTHORIZED TO ASSUME FOR SELLER ANY OBLIGATION OR LIABILITY NOT STRICTLY IN ACCORDANCE WITH THE FOREGOING.

